



**ONE OCEAN EXPEDITIONS
WORLDWIDE CRUISE PORTFOLIO**

2018-2019



ONE OCEAN EXPEDITIONS
EXPANDS THE FLEET:
EXPEDITION CRUISING
CONTINUES TO EVOLVE





INTRODUCING RCGS RESOLUTE

The 10th year of One Ocean Expeditions will see the expansion and enhancement of the OOE expedition cruise fleet. In November 2018, RCGS Resolute, a purpose built polar expedition passenger vessel, will join Akademik Ioffe and Akademik Sergey Vavilov under the One Ocean Expeditions banner, offering the most capable, safe and exclusive expedition cruise fleet in the industry.

Built in Rauma, Finland the same shipyard as Akademik Ioffe & Akademik Sergey Vavilov, RCGS Resolute offers modern stabilization and unsurpassed ice classification (Lloyds 1AS) compliant with the new Polar Code. Between all three vessels One Ocean Expeditions is perfectly equipped with the right hardware and programming to offer our full range of activities, guiding our adventurous guests on their quest to imagine, explore and discover the world's most remote and inspiring regions.

Based on popular demand One Ocean Expeditions has built new product expansion between Antarctica and the High Arctic onboard RCGS Resolute. New itineraries available in the spring of 2019 range from the Chilean Fjords, the West and East Coasts of Central America (Costa Rica, Panama, Cuba) including a transit through the Panama Canal. Those interested in exploring the Viking trade routes of Scotland and Iceland can choose to spend 7 nights on our expedition golf voyage including some of the world's most prestigious and acclaimed golf courses, expedition style. For our more traditional wildlife, photography and adventure voyages, the coastal highlands of Northern Scotland offer incredible vistas and expansive hiking opportunities. Wrapping up the spring season with a comprehensive exploration of Iceland, Scotland and the Faroe Islands; guests may simply just choose to stay onboard a while! Canada's East Coast and the Canadian Arctic allow more travel options for our ever popular expedition golf voyage (Fiddles & Sticks) packaged just prior to our back to back 12-night Northwest Passage voyages — an absolute must. Join us in celebration, as we evolve and welcome RCGS Resolute into our expedition cruising fleet.



AKADEMIK IOFFE

BUILT: 1989
SHIPYARD: Rauma, Finland
ICE CLASSIFICATION: Lloyds 1A ice-strengthened vessel
STABILIZERS: Yes
JOINED OOE FLEET: 2008
PASSENGERS: 96



AKADEMIK SERGEY VAVILOV

BUILT: 1988
SHIPYARD: Rauma, Finland
ICE CLASSIFICATION: Lloyds 1A ice-strengthened vessel
STABILIZERS: Yes
JOINED OOE FLEET: 2009
PASSENGERS: 92



RCGS RESOLUTE

BUILT: 1993
SHIPYARD: Rauma, Finland
ICE CLASSIFICATION: Lloyds 1AS, ice-strengthened vessel
STABILIZERS: Yes
JOINS OOE FLEET: 2018
PASSENGERS: 146



CANADIAN SIGNATURE
EXPERIENCE
CANADIENNE DISTINCTIVE

REMOTE PORTS. LIVELY MUSIC. INCREDIBLE WILDLIFE.

The Atlantic East Coast of Canada is the summer playground for many travellers worldwide. Rich in folklore, culture, hiking and wildlife; One Ocean Expeditions' East Coast voyages offer incredible experiences for all ages and interests. Along the shores of the Canadian Atlantic East Coast, we are welcomed by the familiarity of days gone by in each community we visit. Within these colourful and vibrant Atlantic Provinces we experience true wildlife in its natural habitat, as we transition away from life as we know it. By relocating our vessel overnight, we achieve optimal itineraries otherwise unattainable in this region. The extensive grouping of remote offshore islands and provinces included in this program range from Louisbourg, Nova Scotia, all the way up to Iqaluit, Nunavut. Undoubtedly best explored by an expedition cruise, your spirit of adventure leads the way and opportunities are maximized each and every day.



CANADA'S EAST COAST

2018









CANADA'S EAST COAST















Dates & Rates — Canada's East Coast 2018

ONE OCEAN NAVIGATOR / AKADEMIK IOFFE

All prices are US\$ per person.

DATE	NIGHTS	ACTIVITIES	ITINERARY	START/END	TRIPLE SHARE	TW IN SEM-PRIVATE	TWIN PRIVATE	SUPERIOR	SHACKLETON SUITE	ONE OCEAN SUITE	CHARTER FLIGHTS
27 JUN 18 04 JUL 18	7		CANADA'S EAST COAST GOLF EXPEDITION: FIDDLES & STICKS 	LOUISBOURG	3395	4395	5695	6395	7795	9395	N/A
04 JUL 18 14 JUL 18	10		CANADA'S EAST COAST FINS & FIDDLES	LOUISBOURG	3395	4395	5695	6395	7795	9395	N/A
14 JUL 18 24 JUL 18	10		CANADA'S EAST COAST FINS & FIDDLES 	LOUISBOURG	3395	4395	5695	6395	7795	9395	N/A
24 JUL 18 03 AUG 18	10		LABRADOR & TORNGAT EXPLORER 	LOUISBOURG IQUALUIT	3695	4695	6295	6795	8295	9895	995



Supplement: 1.5 of the twin occupancy cabins and 2 for the suites (single supplements not available for the triple share cabins). Kayaking on Labrador & Torngat Explorer voyage: US\$695. The icons above indicate higher probability for specific activities:  educational programming,  photographer in residence,  enhanced photography,  photographic symposiums,  sea kayaking,  stand-up paddling,  bicycling,  whale watching,  polar bear,  zodiac,  wildlife watching,  hiking,  yoga/fitness,  family,  golfing. Please see detailed trip notes for detailed itinerary. Itineraries may be slightly altered or operated in reverse, dependant on ice/weather conditions at the time. GST (Canada): All bookings on voyages that operate domestically within Canada, are subject to a compulsory 5% goods and services tax (GST). This will be itemized separately to the cruise price on the confirmation invoice.



CANADA'S EAST COAST

Voyage Descriptions — Canada's East Coast 2018

- **EAST COAST GOLF EXPEDITION: FIDDLES & STICKS** North America's first expedition golf voyage offering opportunities to play at some of the finest golf courses in Canada — several of which feature in the 'Top 100' golf courses in the world! Golfers from around the world are drawn by the superb challenges offered and the magnificent coastal settings. Relaxation has never been easier between courses. Each day our expedition plan unfolds onto a new course, where clubs and lunches are transferred ashore via zodiac. Imagine approaching the 1st hole by way of the shoreline! Confirmed course locations include Cabot Links, Cabot Cliffs, Crowbush, and Highland Links. We even hope to play a round on the picturesque island of Les Illes de la Madeleine, located in the Gulf of St. Lawrence.
- **CANADA'S EAST COAST: FINS & FIDDLES** Immerse yourself in everyday 18th century life in a French fortress in Louisbourg, Nova Scotia, then set sail into the North Atlantic on a small, ice-strengthened expedition ship while savouring fresh local lobster. Wake up to the mystique of the remote Sable Island, where wild horses run free on grassy dunes and grey seals bark from sandy shores of waters scattered with 350 shipwrecks. Explore Canadian history in genteel Charlottetown, PEI, where the pivotal conference that set Canada's Confederation in motion was set. Kayak or stand-up paddle board across glassy waters, and cruise on a guided zodiac tour, or head ashore to hike or cycle. In Newfoundland and Labrador, sail alongside soaring fjord walls streaming with waterfalls in Gros Morne National Park, a UNESCO World Heritage Site. Drop in for wine and cheese at a petite outpost of France off Canada's coast, then along the coastlines of Iles-de-la-Madeleine and Anticosti Island in Quebec. All optional activities are included in the voyage price.
- **LABRADOR & TORNGAT EXPLORER** This voyage links several fascinating historic locations on Canada's East Coast, with an incredible transition from the East Coast provinces of Canada to the heart of the Arctic. Opportunities include: a hike to the world heritage Tablelands National Park (a place where the Earth's mantle is exposed on the surface), a visit to remote Moravian mission outposts, isolated fishing ports, Basque settlements and the French-built Fortress of Louisbourg (a National Historic Site of Canada). Exploring the breathtaking wilderness of Torngat Mountains National Park offers incredible photographic opportunities as well as a range of wildlife and is one of the only places in Canada where it is possible to see a black bear and polar bear in the same day!





BAFFIN ISLAND

IQALUIT

MONUMENTAL ISLAND

BUTTON ISLANDS

TORNGAT MOUNTAINS NATIONAL PARK

HEBRON

HOPEDALE

BATTLE HARBOUR

L'ANSE AUX MEADOWS

NEWFOUNDLAND AND LABRADOR

GROS MORNE NATIONAL PARK

QUÉBEC

ISLES DE LA MADELEINE

INGONISH

ENGLISH TOWN

LOUISBOURG

INVERNESS

PRINCE EDWARD ISLAND

NOVA SCOTIA

SABLE ISLAND



MORE OPPORTUNITIES TO EXPERIENCE

The Arctic carries great exploration and historical interest worldwide. The Canadian Arctic and Inuit communities on the east coast of Baffin Island and the west coast of Greenland offer incredible insight into life above the Arctic Circle. Zodiac cruising at the base of glacial walls or bird cliffs is a humbling experience in the North. Visiting remote Northern communities that welcome us into their way of life gives us perspective and furthers our appreciation for their customs and lifestyle. By creating voyages that offer a range of opportunities to experience culture, history and wildlife, there has never been a better way to immerse yourself in the Arctic. The sight of your first polar bear, walrus, narwhal, beluga, caribou and muskox elicits a feeling of awe in even the most experienced traveller. To explore these incredibly remote areas, One Ocean Expeditions operates chartered aircraft specially equipped for gravel runways and Northern access. One Ocean Expeditions offers customized itineraries in remote and often untouched sections of the Arctic, explored in small groups and led by expert guides.

THE ARCTIC

2018



THE ARCTIC

Dates & Rates — Arctic 2018

ONE OCEAN VOYAGER / AKADEMIK SERGEY VAVILOV

All prices are US\$ per person.

DATE	NIGHTS	ACTIVITIES	ITINERARY	START/END	TRIPLE SHARE	TWIN SEMI-PRIVATE	TWIN PRIVATE	SUPERIOR	SHACKLETON SUITE	ONE OCEAN SUITE	CHARTER FLIGHTS
19 JUN 18 28 JUN 18	9		SPTSBERGEN ENCOUNTER PHOTOGRAPHY SYMPOSIUM	LONGYEARBYEN	5695	7195	8195	9395	10295	11395	N/A
28 JUN 18 07 JUL 18	9		SPTSBERGEN ENCOUNTER	LONGYEARBYEN	5695	7195	8195	9395	10295	11395	N/A
12 AUG 18 24 AUG 18	12		CLASSIC NORTHWEST PASSAGE & GREENLAND	KANGERLUSSUAQ CAMBRIDGE BAY	9595	11395	13695	14695	16095	17095	1995
24 AUG 18 05 SEPT 18	12		CLASSIC NORTHWEST PASSAGE & GREENLAND	CAMBRIDGE BAY KANGERLUSSUAQ	9595	11395	13695	14695	16095	17095	1995
05 SEPT 18 15 SEPT 18	10		WEST GREENLAND & BAFFIN ISLAND EXPLORER	KANGERLUSSUAQ IQALUIT	6695	7595	8995	9495	10895	12295	1995

ONE OCEAN NAVIGATOR / AKADEMIK IOFFE

All prices are US\$ per person.

DATE	NIGHTS	ACTIVITIES	ITINERARY	START/END	TRIPLE SHARE	TWIN SEMI-PRIVATE	TWIN PRIVATE	SUPERIOR	SHACKLETON SUITE	ONE OCEAN SUITE	CHARTER FLIGHTS
03 AUG 18 14 AUG 18	11		BAFFIN ISLAND JEWEL OF THE HIGH ARCTIC	IQALUIT RESOLUTE	7295	8295	9895	10395	11895	13495	1995
14 AUG 18 23 AUG 18	9		HIGH ARCTIC EXPLORER	RESOLUTE	6795	7795	9395	10095	11395	12995	1995
23 AUG 18 01 SEPT 18	9		PATHWAYS TO FRANKLIN	RESOLUTE CAMBRIDGE BAY	6795	7795	9395	10095	11395	12995	1995
01 SEPT 18 13 SEPT 18	12		CLASSIC NORTHWEST PASSAGE & BAFFIN ISLAND	CAMBRIDGE BAY IQALUIT	9595	11395	13695	14695	16095	17095	1995

Supplement: 1.5 of the twin occupancy cabins and 2 for the suites (single supplements not available for the triple share cabins). Kayaking: US\$695. The icons above indicate higher probability for specific activities: educational programming, photographer in residence, photographic symposiums, sea kayaking, whale watching, polar bear, zodiac, wildlife watching, hiking, yoga/fitness, family. Please see trip notes for detailed itinerary. Itineraries may be slightly altered or operated in reverse, dependant on ice/weather conditions at the time. GST (Canada): All bookings on voyages that operate domestically within Canada, are subject to a compulsory 5% goods and services tax (GST). This will be itemized separately to the cruise price on the confirmation invoice.



THE CANADIAN ARCTIC & WESTERN GREENLAND

Voyage Descriptions — Arctic 2018

The Canadian Arctic offers an epic, life changing opportunity when explored by small expedition cruise ship. Years spent exploring these waters provide us with an intrinsic understanding of both the ice and the wildlife areas popular with whales, seals and of course the elusive hunters of the North — polar bears.

- **BAFFIN ISLAND – JEWEL OF THE ARCTIC** Baffin Island is one of the last great wilderness regions on the planet and the focus of our outstanding expedition. From Iqaluit we explore up the east coast of Baffin Island discovering deep fjords, soaring mountains, immense glacial systems, remote Inuit communities, and incredible wildlife. This is small ship expedition cruising at its best.
- **HIGH ARCTIC EXPLORER** This 9-night stunning journey is the perfect combination of wildlife, history and scenery. The long hours of daylight give us maximum time to explore known wildlife hot spots including one of the largest migratory bird sanctuaries in the world, Prince Leopold Island. Landing areas include Grise Fiord, Craig Harbour, Dundas Harbour and Beechey Island, all located above 64th parallel. Along the ice floe edge we encounter beluga and bowhead whales and hope to encounter the mythical narwhal. Sightings of polar bears can be expected at numerous locations throughout the voyage.
- **PATHWAYS TO FRANKLIN** The principal focus of this 9-night expedition is the history of Arctic exploration and the early quest for the Northwest Passage. The story of Sir John Franklin's expedition from the mid 18th century and the enduring mystery of their fate have gripped the imagination for more than 170 years. A new chapter in this tale was written in September 2014 when the Victoria Strait Expedition, a joint government/private endeavour (of which One Ocean Expeditions is a proud partner) was successful in the find of Sir John Franklin's HMS Erebus. We navigate through these waters and wonder about the fate of these early Arctic explorers.
- **CLASSIC NORTHWEST PASSAGE** The Northwest Passage is one of the world's most iconic maritime routes of discovery. This 12-night voyage covers the full spectrum of Arctic scenery, culture, history and wildlife — making it a much-loved classic. We follow in the footsteps of the early Arctic explorers such as Franklin, Amundsen and Larsen, exploring the vast archipelago of islands and channels that create Canada's High Arctic region. This is the home of the polar bear, barren land grizzly, muskox, caribou, walrus, beluga and possibly even the narwhal. There are several variations to this itinerary — east to west, west to east — linking the west coast of Greenland to Cambridge Bay, in the heart of the Northwest Passage.
- **WEST GREENLAND & BAFFIN ISLAND EXPLORER** An exploration of the wildlife, culture and spectacular scenery in Western Greenland and the Canadian Arctic. From Kangerlussuaq on the west coast of Greenland to Iqaluit on the east coast of Baffin Island, this 11-day adventure sails through a spectacular wilderness of glaciers, mountains, fjords and breathtaking icebergs. Along the way, Inuit settlements of both Greenland and Canada will open eyes to the rich and unique cultures that have survived in this harsh landscape for centuries.





SPITSBERGEN

Voyage Descriptions — Arctic 2018

Spitsbergen and the Svalbard archipelago offer tremendous wildlife and birdlife experiences, as well as a fascinating lesson in glaciology. The islands are the northernmost inhabited places on the planet and would be permanently locked in ice if not for the moderating influence of the Atlantic Gulf Stream. Our series of voyages focus on the western quarter of the island group. This area has the highest concentration of wildlife and places of historic and scenic interest in the archipelago. The unique ice capabilities of our ships allow us to venture to the edge of the permanent Arctic pack ice where few other vessels can, at around 80 degrees north latitude. It is in this vicinity we typically enjoy our best encounters with polar bears.

- **SPITSBERGEN ENCOUNTER** On this 9-night voyage we focus our attention on the upper northwest islands of Spitsbergen — the largest island in the Svalbard archipelago. Sailing along the coast we visit numerous bird colonies and enjoy regular encounters with bearded and ringed seals. Days are busy with shore excursions to places of historic interest, visits to wildlife colonies, viewing the exquisite native flora and soaking up stunning Arctic landscapes. Short or long hikes on shore are another highlight, along with regular cruising in the zodiacs. Our voyage continues to remote Phippsøya, where we have our best chance to see polar bears. Returning south, we stop at Monaco Glacier and Liefdefjorden — another well known spot for bears.
- **SPITSBERGEN ENCOUNTER — PHOTOGRAPHY SYMPOSIUM** This brilliant voyage offers the same itinerary as One Ocean Expeditions' classic 9-night Spitsbergen Encounter with all the same great guides and educational elements. Unique to this departure is a custom program designed for photography enthusiasts. This program runs parallel to our daily off-ship excursions and activities. The photography team, led by Nikon master and award-winning photographer Daisy Gilardini, provides practical guidance and deep insight. Special excursions will include early mornings and late evenings chasing the gorgeous Arctic light. The program is open to photographers of all abilities and is included as part of the voyage.





SPEND MORE TIME. ENJOY MORE VARIETY. APPRECIATE MORE COMFORT.

Towering glaciers, amazing wildlife encounters with penguins, whales and seals, snow-covered landscapes, enormous icebergs and the option to choose your favourite activities every day, characterize travelling with One Ocean Expeditions. Our exciting expeditions include flights from Punta Arenas, Chile or the option to sail across the Drake Passage to Antarctica, providing great diversity and appeal to those seeking a truly comprehensive Antarctic experience. Our expedition ships offer a platform similar to that of a floating wilderness lodge, which we reposition every day to yet another exciting location. We break into small special interest groups, discovering Antarctica and its remarkable wildlife through hikes onshore, zodiac cruising and photography. For the more adventurous, overnight camping and sea kayaking options are available. Visits to historic huts and working research stations add another dimension to the voyage. One Ocean Expeditions is proud to continually improve the comforts found onboard and to ensure maximum relaxation on your voyage of a lifetime. Extensive upgrades across all passenger areas and cabins onboard Akademik Ioffe and Akademik Sergey Vavilov will be in place for Antarctica 2018-2019. If joining RCGS Resolute, our guests will be pleased with the expanded menu offerings, additional viewing lounges, and expansive wellness program.



ANTARCTICA

2018 – 2019



ANTARCTICA

Dates & Rates — Antarctic 2018-2019

ONE OCEAN NAVIGATOR / AKADEMIK IOFFE

All prices are US\$ per person.

DATE	NIGHTS	ACTIVITIES	ITINERARY	START/END	TRIPLE SHARE	TWIN SEMI-PRIVATE	TWIN PRIVATE	SUPERIOR	SHACKLETON SUITE	ONE OCEAN SUITE
20 OCT 18 07 NOV 18	18		FALKLAND ISLANDS, SOUTH GEORGIA & ANTARCTICA	STANLEY USHUAIA	13595	15595	17495	18495	20295	22295
07 NOV 18 19 NOV 18	12		ANTARCTICA OFF THE BEATEN TRACK	USHUAIA	8895	11195	12295	13095	14895	16695
19 NOV 18 29 NOV 18	10		ANTARCTIC PENINSULA ADVENTURE	USHUAIA	8695	10795	11795	12795	13995	15895
29 NOV 18 17 DEC 18	18		FALKLAND ISLANDS, SOUTH GEORGIA & ANTARCTICA	USHUAIA	14295	16395	18495	19395	21395	23095
17 DEC 18 27 DEC 18	10		CHRISTMAS IN ANTARCTICA	USHUAIA KGI	11195	13195	14295	14995	16495	18095
27 DEC 18 12 JAN 19	16		ANTARCTICA, SOUTH GEORGIA & FALKLAND ISLANDS	KGI STANLEY	16295	18595	20595	21995	23795	25595
12 JAN 19 22 JAN 19	10		QUEST FOR THE ANTARCTIC CIRCLE	STANLEY KGI	11195	13195	14295	14995	16495	18095
12 JAN 19 02 FEB 19	21		EPIC ANTARCTICA	STANLEY	19290	22490	24290	25490	27890	30390
22 JAN 19 02 FEB 19	11		ULTIMATE ANTARCTICA, WEDDELL SEA & FALKLAND ISLANDS	KGI STANLEY	12095	14295	15995	16895	18695	20295
02 FEB 19 18 FEB 19	16		FALKLAND ISLANDS, SOUTH GEORGIA, & ANTARCTICA	STANLEY KGI	16295	18595	20595	21995	23795	25595
18 FEB 19 04 MAR 19	14		ANTARCTIC DEEP SOUTH (EXTENDED CIRCLE VOYAGE)	KGI USHUAIA				SOLD OUT		
04 MAR 19 14 MAR 19	10		ANTARCTIC PENINSULA ADVENTURE	USHUAIA	8695	10795	11795	12795	13995	15895
14 MAR 19 24 MAR 19	10		ANTARCTIC PENINSULA ADVENTURE	USHUAIA				SOLD OUT		
24 MAR 19 03 APR 19	10		ANTARCTIC PENINSULA ADVENTURE	USHUAIA	8695	10795	11795	12795	13995	15895

Single supplement: 1.5 of the twin occupancy cabins and 2 for the suites (single supplements not available for the triple share cabins). Kayaking: US\$795. The icons above indicate higher probability for specific activities: photography, enhanced photography, expedition photography, photographic symposiums, sea kayaking, snowshoeing, whale watching, skiing, camping, possibility of zodiac, wildlife watching, hiking, yoga/fitness, family, educational programming. Please see trip notes for detailed itinerary. Itineraries may be slightly altered or operated in reverse, dependant on ice/weather conditions at the time.

ARGENTINA

CHILE

PUNTA
ARENAS

USHUAIA

FALKLAND
ISLANDS

PORT
STANLEY

SOUTH
GEORGIA
ISLAND

LIVINGSTON
ISLAND

KING
GEORGE
ISLAND

ELEPHANT
ISLAND

SOUTH
ORKNEY
ISLANDS

DECEPTION
ISLAND

WEDDELL SEA

LEMAIRE
CHANNEL

ANTARCTICA

GERLACHE
STRAIT

DETAILLE
ISLAND

ANTARCTIC CIRCLE

oneocean
EXPEDITIONS

ANTARCTICA

Voyage Descriptions – One Ocean Navigator / Akademik Ioffe, Antarctica 2018-2019

For many, a voyage to Antarctica is truly the trip of a lifetime. Once there, you should choose how your Antarctic experience unfolds. If watching penguins is your priority — then we will set you up next to a busy rookery. Maybe a long hike to a snowy peak is the real reason you came all this way. We make it happen. Photographing icebergs? You will never tire of it. We achieve all of this through exceptional customer service by having the highest staff to passenger ratio in the industry. This season, One Ocean Navigator/Akademik Ioffe will operate a series of 'classic' Antarctic voyages departing from Ushuaia, Argentina. We also include several new itineraries incorporating flights from Punta Arenas, Chile to Antarctica or to Stanley, Falkland Islands, saving time on sea crossings. Expeditions range from 10 to 19 nights in duration, visiting all of the much-loved locations and a few lesser known gems we have discovered over the years.

- **FALKLAND ISLANDS, SOUTH GEORGIA, ANTARCTICA** Available in 16 or 18 night itineraries, with options to choose different embarkation points ranging from Stanley, Falkland Islands, Ushuaia, Argentina, and even King George Island, Antarctica. This is our most far-reaching polar journey and includes visits to three different regions. The sub-Antarctic Falkland Islands and the island of South Georgia are home to an abundance of unique wildlife. There are penguin rookeries with more than 100,000 nesting birds and the beaches are covered with fur seals and elephant seals. Seabirds, including many of the albatross species, call these islands home. Both regions feature fascinating history and stunning scenery. To the south lies Antarctica — the frozen continent and our final destination on this remarkable voyage. Icebergs in all shapes and sizes fill the waters and more unique wildlife can be found living in sizeable colonies. The waters are full of life and we frequently encounter whales including humpback, minke and orca. Travelling this far — you might as well stay a while!
- **ANTARCTICA – OFF THE BEATEN TRACK** This comprehensive and diverse voyage offers zodiac cruising, onshore walks and hikes, visits to wildlife colonies, exploration of historic sites/scientific stations, and excursions to discover the beautiful bays and landing sites found along the Antarctic Peninsula. This voyage combines untouched Antarctica and plenty of options to enjoy an exciting range of outdoor offerings. Love outdoor activity? So do we! Only on this 12-night voyage can our guests participate in ski touring, expedition snowshoeing, sea kayaking with an overnight camping option and our expedition field photography workshops. Our entry into Antarctica is one of the first of the season, and is met with pristine conditions following the heavy snowfall of the Antarctic winter. This is untouched wilderness at its finest.
- **CHRISTMAS IN ANTARCTICA** December provides maximum hours of daylight as we experience Antarctica during the summer solstice. By starting this voyage in Ushuaia, Argentina and disembarking on King George Island, Antarctica, time is optimized for the best experiences. Over the course of 10 nights, we visit many of the classic locations along the Antarctic Peninsula providing a great variety of exciting activities both on and off the ship. Traditionally, this departure has been very popular with families as it falls over the holiday season. Join us for the most wonderful 'white Christmas' you could ever imagine surrounded by icebergs, crystal clear waters, astonishing wildlife and create memories that will last a lifetime.
- **QUEST FOR THE ANTARCTIC CIRCLE** This popular voyage allows us to reach our objective of the Antarctic Circle in just 10 nights, compared with the traditional 13-night program. We achieve this by the clever time-saving use of a flight to Port Stanley, Falkland Islands to commence the voyage. At the conclusion of the trip, we fly back from Antarctica to South America, crossing the Drake Passage in just over 2 hours instead of the usual 2 days. This voyage includes a possible 8 days filled with excursions on the zodiacs and onshore. For a relatively short voyage, this trip packs a serious punch, offering fantastic diversity of scenery, wildlife and historic and scientific interest. A hotel night at the end of the voyage in Punta Arenas, Chile is included.

- **ULTIMATE ANTARCTICA – WEDDELL SEA & FALKLAND ISLANDS** Diversity of experiences, destinations and wildlife encounters in Antarctica provide the highlights for this exceptional voyage. We fly south to Antarctica in just 2 hours, crossing the Drake Passage. A further exploration of the South Shetland Islands and Antarctic Peninsula coastline sets the scene, before heading into the spectacular Weddell Sea - home to the 'big ice'. Here, gigantic tabular icebergs surround us and an all together different feel will be experienced. This is wild and remote Antarctica. We journey north, stopping at Elephant Island - a very historic location central to the Shackleton story. The great pelagic seabirds join us as we navigate north towards the Falkland Islands. A final highlight will be a visit to the king penguin colony at Saunders Island, or Volunteer Point - finishing this epic voyage in Port Stanley, Falkland Islands.
- **EPIC ANTARCTICA** This exciting new 21-night expedition has been many years in the making. It is undoubtedly the most comprehensive journey to Antarctica ever offered. This unique experience links two existing voyages to create one 'super adventure'. Over the course of 3 weeks, we spend an unprecedented 16 days exploring the Antarctic Peninsula, South Shetland Islands, the spectacular icy Weddell Sea region and the wildlife rich Falkland Islands.
- **ANTARCTIC PENINSULA ADVENTURE** This incredible 10-night voyage starts in Ushuaia, Argentina, the most southern city in the world, otherwise known as the gateway to Antarctica. The wildlife is abundant from the first time we throw the lines and make our way into the Beagle Channel, towards the Drake Passage, historically known for its incredible ocean currents and migration paths for numerous species of seabirds and marine mammals. This sea crossing allows for the delivery of an incredible educational program presented by world leading specialists in their noted field of expertise (history, marine biology, geology, photography, etc) through an interactive series of presentations sure to prepare eager travellers for their trip of a lifetime. The One Ocean Expeditions commitment to deliver a variety of excursions encompassing different activities (including the option to camp onshore), allows guests to choose how their expedition unfolds. Antarctica unleashes her majestic qualities of amazement as we explore and discover the key landing and excursion areas of the peninsula showcasing penguins, seals, whales, seabirds, and epic ice.



ANTARCTICA

Dates & Rates — Antarctic 2018-2019

ONE OCEAN VOYAGER / AKADEMIK SERGEY VAVILOV



All prices are US\$ per person.

DATE	NIGHTS	ACTIVITIES	ITINERARY	START/END	TRIPLE SHARE	TWIN SEMI-PRIVATE	TWIN PRIVATE	SUPERIOR	SHACKLETON SUITE	ONE OCEAN SUITE
03 NOV 18 17 NOV 18	14		SOUTH GEORGIA IN DEPTH- PHOTOGRAPHY SYMPOSIUM	STANLEY	9895	11995	13195	14095	15995	17695
17 NOV 18 03 DEC 18	16		SOUTH GEORGIA IN-DEPTH	STANLEY USHUAIA	10595	12895	14195	15095	17095	18995
03 DEC 18 13 DEC 18	10		ANTARCTICA IN-DEPTH (EXTENDED PENINSULA VOYAGE)	USHUAIA KGI	9695	11995	12695	13395	14695	15995
13 DEC 18 29 DEC 18	16		ANTARCTICA, SOUTH GEORGIA & FALKLAND ISLANDS	KGI STANLEY	15995	18195	20295	21695	23395	25295
29 DEC 18 08 JAN 19	10		QUEST FOR THE ANTARCTIC CIRCLE	STANLEY KGI	11195	13195	14295	14995	16495	18095
08 JAN 19 21 JAN 19	13		ANTARCTICA DEEP SOUTH (EXTENDED CIRCLE VOYAGE)	KGI USHUAIA	14195	16895	18795	19995	21995	23995
21 JAN 19 09 FEB 19	19		ANTARCTICA, SOUTH GEORGIA & FALKLAND ISLANDS	USHUAIA STANLEY	19095	22595	24795	26195	27895	29095
09 FEB 19 19 FEB 19	10		QUEST FOR THE ANTARCTIC CIRCLE	STANLEY KGI	11195	13195	14295	14995	16495	18095
19 FEB 19 03 MAR 19	12		ANTARCTICA DEEP SOUTH (EXTENDED CIRCLE VOYAGE)	KGI USHUAIA	13095	15595	17395	18395	20295	22195
03 MAR 19 13 MAR 19	10		MARINE MAMMALS OF ANTARCTICA	USHUAIA	8695	10795	11795	12795	13995	15895
13 MAR 19 23 MAR 19	10		ANTARCTIC PENINSULA ADVENTURE	USHUAIA				SOLD OUT		
23 MAR 19 02 APR 19	10		MARINE MAMMALS OF ANTARCTICA	USHUAIA	8695	10795	11795	12795	13995	15895

Single supplement: 1.5 of the twin occupancy cabins and 2 for the suites (single supplements not available for the triple share cabins). Kayaking: US\$795. The icons above indicate higher probability for specific activities: photography, enhanced photography, expedition photography, photographic symposiums, sea kayaking, snowshoeing, whale watching, skiing, camping, possibility of camping, zodiac, wildlife watching, hiking, yoga/fitness, family, educational programming. Please see trip notes for detailed itinerary. Itineraries may be slightly altered or operated in reverse, dependant on ice/weather conditions at the time.

ARGENTINA

CHILE



PUNTA ARENAS

USHUAIA

FALKLAND ISLANDS

PORT STANLEY

SOUTH GEORGIA ISLAND

SOUTH ORKNEY ISLANDS

KING GEORGE ISLAND

ELEPHANT ISLAND

LIVINGSTON ISLAND

DECEPTION ISLAND

WEDDELL SEA

LEMAIRE CHANNEL

ANTARCTICA

GERLACHE STRAIT

ANTARCTIC CIRCLE

ADELAIDE ISLAND

DETAILLE ISLAND

MARGUERITE BAY



ANTARCTICA

Voyage Descriptions – One Ocean Voyager / Akademik Sergey Vavilov, Antarctica 2018-2019

Launched 2 years ago, these unique voyages have proven very popular with those seeking to maximize their time spent in Antarctica. By flying from Punta Arenas, Chile to the gateways of Port Stanley in the Falkland Islands, or King George Island in Antarctica, we save several days of open ocean crossings. Rather than shortening the total Antarctic experience and operating hurried 6 or 7 day voyages, we add these 'saved days' to the expedition and see even more. We don't know anyone that ever went all the way to Antarctica to rush the experience. This is a refreshing new angle on the 'air access to Antarctica' concept and unique to One Ocean Expeditions.

- **SOUTH GEORGIA IN-DEPTH – PHOTOGRAPHIC SYMPOSIUM** This 14-night itinerary features incredible wildlife encounters, fascinating history and gorgeous scenery. For lovers of wildlife, remote destinations and epic scenery, this is the trip to choose. Only on these voyages will you have the privilege to spend more consecutive days exploring South Georgia. Here you will witness what has often been described as the 'greatest wildlife show on Earth'. Unique to this departure is a custom program designed for photography. This program runs parallel to our daily off ship excursions and activities. The photography team, led by Nikon master and award-winning photographer, Daisy Gilardini, provides practical guidance and deep insight. Special excursions will include early mornings and late evenings chasing the gorgeous Antarctic light. The program is open to photographers of all abilities and is included as part of the voyage.
- **SOUTH GEORGIA IN-DEPTH** This popular 16-night voyage offers the best South Georgia has to offer. Only on this voyage will you have the privilege of spending more consecutive days exploring South Georgia. Here you will witness what has often been described as the 'greatest wildlife show on Earth'. The story of Sir Ernest Shackleton and the Endurance expedition from over a century ago is forever connected to the island. Today, the place teems with wildlife on a jaw-dropping scale. King penguin rookeries are home to more than a hundred-thousand birds, seals cover the beaches and nesting seabirds fill the skies. This voyage embarks in Stanley, Falkland Islands and disembarks in Ushuaia, Argentina.
- **ANTARCTICA IN-DEPTH** This voyage encompasses 2 additional days of exploration in Antarctica without adding to the total length of the voyage. We achieve this by flying back from King George Island (Antarctica) to South America at the end of the voyage, saving 2 days on the return sea crossing. Those 2 days 'saved' are spent exploring in Antarctica. This equals more time on shore, more time in the zodiacs and more time spent in the company of our expert guides.
- **ANTARCTICA, SOUTH GEORGIA, FALKLAND ISLANDS** December is a beautiful time to experience Antarctica. We enjoy extended daylight hours, the wildlife colonies are busy and as the sea ice continues to break up, our range of landing sites expands even further. We fly from South America to Antarctica in a little over 2 hours where we board our ship before exploring the glaciated coastline of the Antarctic Peninsula.
- **QUEST FOR THE ANTARCTIC CIRCLE** This unique expedition provides a modern twist on a much loved classic. Utilizing our decades of experience, this innovative itinerary allows us to reach our objective of the Antarctic Circle in just 11 days. From Punta Arenas, Chile we fly to the embarkation point of Stanley, Falkland Islands. Crossing south to Antarctica we witness the magnificent pelagic seabirds of the southern ocean, including the wandering albatross. This ocean habitat is a fascinating ecosystem in its own right. Navigating our way towards the Circle, we enjoy 7 days with the opportunity of off-ship explorations along the Antarctic Peninsula, visiting a large number of landing sites and cruising among the ice floes in our zodiac boats.

- **ANTARCTICA – DEEP SOUTH** This special journey takes us further south than at any other time in the season. By flying to King George Island in Antarctica at the start of the voyage, we save 2 days on the ocean crossing. The time we save by flying south allows for a more substantial exploration below the Antarctic Circle. Here we witness stunning landscapes, sizeable Adelie penguin rookeries and large flat-topped tabular icebergs that drift north from the Bellingshausen Sea. We anticipate exciting ice navigation when pushing this far south.
- **ANTARCTICA, SOUTH GEORGIA, FALKLAND ISLANDS** The towering peaks and immense glacial systems of the Antarctic Peninsula are home to a great abundance of wildlife which we observe on shore, from the zodiacs and the ship. Large penguin rookeries are found at several locations and we encounter seals and whales in the iceberg filled waterways. Opportunities to visit historic huts and active science stations add further interest. We explore on shore through guided walks which may last up to several hours. Or if you prefer to sit and observe the penguins as they come and go from the water — why not? The more active may choose the sea kayaking option and experience a whole new side of Antarctica.
- **ANTARCTICA DEEP SOUTH** This special journey takes you further south than at any other time in the season. By flying to King George Island in Antarctica at the start of the voyage, we save 2 days on the ocean crossing. The time we save by flying south, allows for a more substantial exploration below the Antarctic Circle. Here we witness stunning landscapes, sizable Adelie penguin rookeries and large flat-topped tabular icebergs that drift north from the Bellingshausen Sea. We always anticipate exciting ice navigation when we push this far south.
- **MARINE MAMMALS OF ANTARCTICA** March is a time of great activity in Antarctic waters and historically we encounter a higher concentration of whales during this period. They are busy feeding prior to their annual migrations to tropical waters. However, scientists are now discovering that some whale species remain in the ice-free sections of Antarctica over winter. On this voyage we plan to visit several known locations along the Antarctic Peninsula that are the focus of long-term research projects by esteemed academic institutions including the University of California (Santa Cruz), California Ocean Alliance and the Australian Antarctic Division's Marine Mammal Centre. We are joined on the ship by several world-renowned cetacean (whale) experts and observe their important scientific fieldwork in close proximity.



ANTARCTICA

Dates & Rates — Antarctic 2018-2019

RCGS RESOLUTE



All prices are US\$ per person.

DATE	NIGHTS	ACTIVITIES	ITINERARY	START/END	MAIN DECK TRIPLE	TWIN PRIVATE	SUPERIOR	SUPERIOR PLUS	SHACKLETON SUITE	ONE OCEAN SUITE
16 NOV 18 28 NOV 18	12		ANTARCTICA OFF THE BEATEN TRACK	PUNTA ARENAS USHUAIA	13295	14495	16695	17095	20095	23695
28 NOV 18 10 DEC 18	12		ANTARCTIC PENINSULA EXPLORER	USHUAIA	SOLD OUT					
10 DEC 18 20 DEC 18	10		ANTARCTIC PENINSULA ADVENTURE	USHUAIA	10995	12195	13995	14295	15795	19695
20 DEC 18 30 DEC 18	10		CHRISTMAS IN ANTARCTICA	USHUAIA	10995	12195	13995	14295	15795	19695
30 DEC 18 17 JAN 19	18		FALKLAND ISLANDS, SOUTH GEORGIA & ANTARCTICA	USHUAIA	19795	21795	24995	25595	28295	35095
17 JAN 19 30 JAN 19	13		JOURNEY BELOW THE ANTARCTIC CIRCLE	USHUAIA	14295	15795	18095	18495	20595	25395
30 JAN 19 17 FEB 19	18		FALKLAND ISLANDS, SOUTH GEORGIA & ANTARCTICA	USHUAIA	19795	21795	24995	25595	28295	35095
17 FEB 19 01 MAR 19	12		ANTARCTIC PENINSULA EXPLORER	USHUAIA	SOLD OUT					
01 MAR 19 11 MAR 19	10		ANTARCTIC PENINSULA ADVENTURE	USHUAIA	SOLD OUT					
11 MAR 19 21 MAR 19	10		ANTARCTIC PENINSULA ADVENTURE	USHUAIA	10995	12195	13995	14295	15795	19695
21 MAR 19 31 MAR 19	10		ANTARCTIC PENINSULA ADVENTURE	USHUAIA	10995	12195	13995	14295	15795	19695
31 MAR 19 13 APR 19	13		CHILEAN FJORDS	USHUAIA VALPARAISO	5695	6995	7295	7655	7895	9895

Single supplement: 1.5 of the twin occupancy cabins and 2 for the suites (single supplements not available for the triple share cabins). Antarctic Kayaking: US\$795, Chilean Fjords Kayaking: US\$495. The icons above indicate higher probability for specific activities: photography, enhanced photography, expedition photography, photographic symposiums, sea kayaking, snowshoeing, whale watching, skiing, camping, possibility of camping, zodiac, wildlife watching, hiking, yoga/fitness, family, educational programming. Please see detailed trip notes for detailed itinerary. Itineraries may be slightly altered or operated in reverse, dependant on ice/weather conditions at the time.



ANTARCTICA

Voyage Descriptions – RCGS Resolute, Antarctica 2018-2019

Offering a wide variety of exceptional voyages based on One Ocean Expeditions Classic itineraries, based in and out of Ushuaia, Argentina. RCGS Resolute's inaugural Antarctic season offers an incredible foray into a full season along the Antarctic Peninsula, Falkland Islands and South Georgia. Built in Rauma, Finland, RCGS Resolute has a specially built hull with increased steel and an ice class rating of Lloyds 1AS. In addition to exceptional ice class, superb stabilization and all the comforts of the world's most capable passenger expedition cruise vessel, One Ocean Expeditions brings all small group activities to life. Enjoy hiking, zodiac cruising, ski touring (AOTBT), photography, wildlife viewing, snowshoeing, camping, and sea kayaking. Add in One Ocean Expeditions' renowned wellness program, which offers yoga, massage and a well stocked gymnasium, and even the most discerning regime can be maintained. Following all of these exciting activities, guests can choose to relax in one of many incredible viewing areas, inside or out. Casual dining with exceptional menu options are paired with an international wine and beverage list.

- **ANTARCTIC PENINSULA ADVENTURE** This classic 10-night voyage features many of the well-known landing sites such as Neko Harbour, Paradise Harbour, Orne Harbour, Cuverville Island and the Errera Channel — and ice conditions permitting, we hope to transit the spectacular Lemaire Channel. Pleneau Island, Petermann Island and the iceberg-filled Penola Strait are all possibilities south of the Lemaire. A further highlight will be a visit to the enchanting South Shetland Islands. Here, we hope to visit Deception Island and other nearby locations such as Half Moon Island, Hannah Point or Yankee Harbour. Returning to South America we have one final thrill — rounding the legendary maritime landmark of Cape Horn.
- **ANTARCTICA OFF THE BEATEN TRACK** Early season is a time of intense activity in Antarctica. The wildlife migrations have commenced and the sea ice is quickly receding, allowing access to locations which have been ice choked since winter. We anticipate exciting ice navigation on the ship and will be among the first to visit many of the well known sites this season. For all these reasons, it's one of our favourite times of the year to visit Antarctica. What makes this journey so special is the enhanced program of off-ship activities offered on this departure. Taking advantage of optimal snow and ice conditions in November, we offer a range of additional activities, such as ski touring and snow shoeing, which complement our regular programming.
- **ANTARCTIC PENINSULA EXPLORER** Expedition cruising in Antarctica is, by its very nature, an exploratory experience. Ice and weather conditions often dictate our planned route. Along with this, we are always opportunistic, stopping when we encounter a pod of whales, or when a gigantic tabular iceberg looms into view. This exciting new itinerary includes 2 extra days of exploration down in Antarctica compared to a classic 10-night voyage. This allows us to visit additional landing sites, or to linger a little longer at some of our favourite locations. In practical terms, you will spend 25% more time down among the ice, when compared to a traditional 10-night itinerary. This equals more time on shore, more time in the zodiacs and more time spent in the company of our expert guides. What's not to like about that?
- **FALKLAND ISLANDS SOUTH GEORGIA, ANTARCTICA** This is our most far-reaching polar expedition and includes visits to three different locations. The sub-Antarctic Falkland Islands and the island of South Georgia are home to a proliferation of unique wildlife and birdlife. There are penguin rookeries with more than 100,000 nesting birds and the beaches are covered in fur seals and elephant seals. Seabirds, including many of the albatross species call these islands home, nesting and raising their young in this wild and remote environment. Both locations feature a fascinating history and stunning scenery.
- **CHRISTMAS IN ANTARCTICA** December provides maximum hours of daylight as we experience Antarctica during the Summer solstice. Over the course of 10 nights, we visit many of the classic locations along the Antarctic Peninsula, providing a great variety of exciting activities both on and off the ship. Traditionally, this departure has been very popular with families as it falls over the holiday season.

- **JOURNEY BELOW THE ANTARCTIC CIRCLE** This remote stretch of the Antarctic Peninsula is visited for just a few short months each year. From January onwards, seasonal ice conditions give us our best chance of achieving our objective — crossing the Antarctic Circle. Here we witness expansive landscapes, sizeable Adelie penguin rookeries and we hope to see the large tabular icebergs that have drifted north from the Bellingshausen Sea. We always anticipate exciting ice navigation on this expedition. Detaille Island, below the Circle is a spectacular location. The snowy peaks which surround us, soar more than 2,000 meters above the ice-strewn waters. We aim to cross 66 degrees, 33 minutes south of latitude, which officially marks the position of the Antarctic Circle on the global map. We then return north, along the heavily glaciated coastline of the Antarctic Peninsula, passing through the Argentine, Fish and Yalour Island archipelagos along the way and into the Gerlache Strait and Danco coast region.
- **CHILEAN FJORDS** If travelling to the ends of the Earth, why not travel back up through the Chilean Fjords? The incredible coastline of Chile offers unparalleled views, wildlife, activities, and even the potential of following the humpback whale migration from Antarctica. This 13-night voyage provides a tremendous opportunity to explore areas otherwise inaccessible by land based excursions. Waking up to a new expedition stop each morning encourages us to dust off our cameras and board the zodiacs, embracing the unknown.





THE ONE OCEAN FOUNDATION

Since its establishment in 2007, One Ocean Expeditions has been contributing to programs aligned with the company's core values of education, exploration, science, socioeconomic development, and sustainable tourism. As part of its commitment to environmental and social responsibility, and to giving back to the communities in which it operates, One Ocean Expeditions created The One Ocean Foundation in early 2017 to house the growing financial contributions from both passengers and the company itself.

Through The One Ocean Foundation, One Ocean Expeditions has developed community outreach programs in partnership with established organizations, and has enabled millions of dollars in financial support to programs focused on food security, recreation and sport, health, science, and youth education.

A range of select beneficiaries and key programs are supported under The One Ocean Foundation, including The Royal Canadian Geographical Society, Vancouver Aquarium, Vancouver Maritime Museum, Oceanites, South Georgia Heritage Trust, Scott Polar Research Institute, and the California Ocean Alliance. Most recently, The One Ocean Foundation announced a new partnership with the Recreation and Parks Association of Nunavut (RPAN), which will help increase the reach and impact of RPAN's sport, recreation and leadership training programs across the North.

As Canada's leading expedition cruise specialist, One Ocean Expeditions is tremendously excited about the opportunity The One Ocean Foundation presents to further expand upon its research and environmental protection initiatives, and its support for local and northern communities.



ONE OCEAN EXPEDITIONS WORLD LEADING, THE WORLD OVER

For a number of years One Ocean Expeditions and The Royal Canadian Geographical Society have maintained a collaborative relationship grounded in geographical education, exploration, science, social and economic community development, Canadian national identity and experiential travel. From the onset of the Victoria Strait Expedition in 2014, which resulted in the successful find of the HMS Erebus, a heightened appreciation for transformative marine experiences has forged a unique collaborative approach to expedition cruising. One Ocean Expeditions is proud to be the exclusive marine travel partner of The Royal Canadian Geographical Society, Canadian Geographic Magazine, & Canadian Geographic PhotoClub for regions offered through One Ocean Expedition itineraries. RCGS Resolute will be the first ship to carry The Royal Canadian Geographical Society's name.

Borne of a joint commitment to continue sharing Canada with the world, this incredible partnership encompasses a multi pillared program exploring new ways to experience and share geography, culture and education. Look for the RCGS compass rose for special departures where additional RCGS programming will be offered, alongside special guests of The Royal Canadian Geographical Society within One Ocean Expeditions onboard team. To learn more about Can Geo Talks, RCGS Expeditions and Research Grants, Canadian Geographic Magazine, and Canadian Geographic Education visit our partner's page online. discover.oneoceanexpeditions.com/Royal-Canadian-Geographical-Society-Partners.

RCGS  SGRC



One Ocean Expeditions is committed to exceptional, responsible, educational & interest led travel to the far reaches of the Earth providing unparalleled value. Guests choose how their expedition unfolds, and are provided the option to participate in small specialized group excursions, specific to their interest. Locally manufactured amenities & tailored programs of interest (photography, history, geology, marine sciences, guided hikes, sea kayaking, camping, health & wellness) complete the feeling of specialized planning and comfort offered in your cabin, throughout the vessel and onshore. One Ocean Expeditions empowers guests to safely experience the world's most remote regions while contributing to the responsible stewardship of its wildlife and natural habitats.

One Ocean Expeditions' vessels offer roll reduction stabilizers, dynamic positioning, powerful engines and an ice classification suitable for polar travel. Matched with multi-pitch propulsion, bow & stern thrusters and outstanding relationships with vessel Captain(s), this ensures maximum maneuverability and the opportunity to respectfully appreciate wildlife. Expansive observation decks offering a 360 degree view provide exceptional wide format photographic and wildlife viewing opportunities at all times.

One Ocean Expeditions, the leader in expedition cruising, provides world class experiences in the protected regions of Antarctica, the High Arctic, the East Coast of Canada, Central America, the Caribbean, the Scottish Highlands, Iceland & the Faroe Islands. Guests become ambassadors for their destination, which continues the shared appreciation and respect for fragile ecosystems and the diversity of remote cultures. Come and experience it for yourself.

- EXCEPTIONAL CUSTOMER SERVICE & INDUSTRY LEADING SAFETY PRACTICES
- PROUDLY CANADIAN, SOCIALLY & ENVIRONMENTALLY RESPONSIBLE
- OFFERING CLIENTS UNIQUE EXPERIENCES IN THE MOST BEAUTIFUL PLACES ON EARTH
- CATERING TO THE HIGHEST DEMANDS OF TODAY'S DISCERNING GUESTS



ONE OCEAN NAVIGATOR

AKADEMIK IOFFE

CABIN & VOYAGE INCLUSIONS	TRIPLE SHARE	TWIN SEMI-PRIVATE	TWIN PRIVATE	SUPERIOR	SHACKLETON SUITE	ONE OCEAN SUITE
OUTSIDE VIEW WITH OPENING PORTHOLE/WINDOW	●	●	●	●	●	●
COMPLIMENTARY USE OF EXPEDITION GEAR PACKAGE (JACKET, PANTS, BOOTS)	●	●	●	●	●	●
COMPLIMENTARY USE OF BINOCULARS, TRECKING POLE & WATERPROOF BACKPACK	●	●	●	●	●	●
CUSTOM BLEND NATURAL CANADIAN-MADE WASHROOM AMENITIES	●	●	●	●	●	●
CUSTOM CANADIAN-MADE LINEN & 'DREAM-SLEEP' PACKAGE	●	●	●	●	●	●
100% COTTON BATHROBE	●	●	●	●	●	●
HAIR DRYER	●	●	●	●	●	●
DIGITAL CLOCK WITH MEDIA CONNECTOR	●	●	●	●	●	●
IN-ROOM TEA & COFFEE STATION	●	●	●	●	●	●
WELCOME PACKAGE & STAINLESS-STEEL WATER BOTTLE	●	●	●	●	●	●
DESK WITH CHAIR	●	●	●	●	●	●
ONE OCEAN EXPEDITIONS WILDLIFE/FIELD GUIDE			●	●	●	●
IN-ROOM PRIVATE REFERENCE LIBRARY				●	●	●
IN-ROOM IPAD PRELOADED WITH REFERENCE & FICTIONAL CONTENT					●	●
DELUXE WELCOME PACKAGE (WINE, FRUIT BASKET & SNACKS)					●	●
SINGLE BREW COFFEE MACHINE					●	●
MINI STEREO					●	●
PRIVATE IN-ROOM ONE OCEAN ADVENTURE CONCIERGE SERVICE					●	●
IN-ROOM MINI-BAR REPLENISHED DAILY (INCL. SPIRITS)					●	●
COMPLIMENTARY FIELD GUIDE					●	●



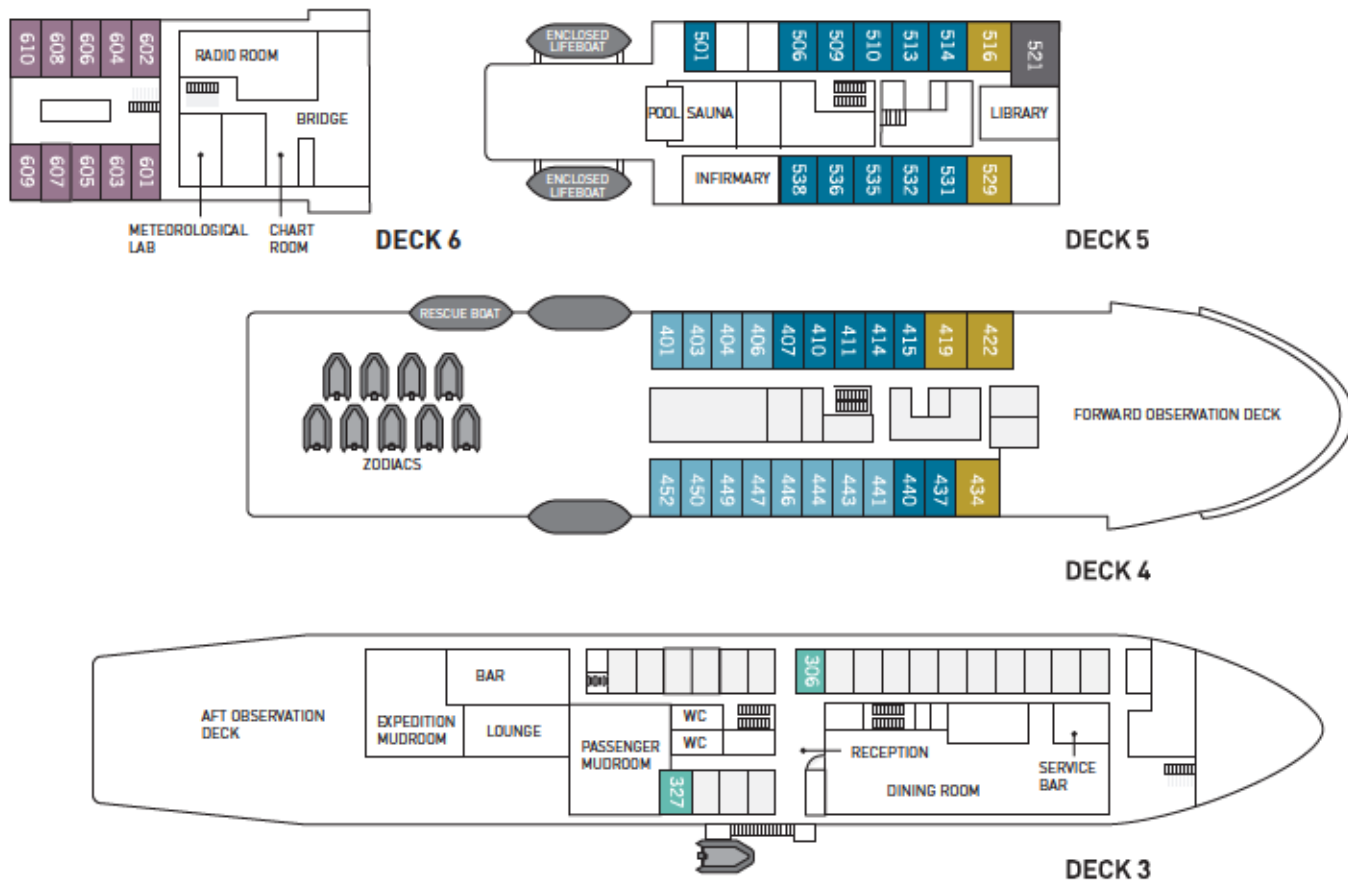

ONE OCEAN NAVIGATOR

Designed for long range polar research, the One Ocean Navigator (Akademik Ioffe) is modern, comfortable, safe and ice-strengthened. She is the near identical sister ship to the One Ocean Voyager (Akademik Sergey Vavilov). From small group sessions to briefings for all passengers, we have public spaces onboard the ship ideally suited for each and every need. A separate lounge and bar, as well as a library provide ideal places to sit and relax or catch up on some reading. A selection of movies and documentaries can also be watched in the lounge. The sumptuous meals prepared for you by our culinary team are enjoyed in our dining room, which can host all clients in a single seating and will keep you feeling healthy and strong for the myriad of activities offered throughout the voyage. Other facilities include the theatre style presentation room, gift-shop, fitness room, massage room, hot water spa, sauna and plunge pool.

ONE OCEAN SUITE ●

Located on deck 5 this cabin is separated into two very spacious rooms. A spacious lounge area is perfect for relaxation and features a sofa (convertible to bed), large table, writing desk, ample storage, plus large picture windows overlooking the bow (forward facing) that can be opened. The separate bedroom features a double bed with upgraded linen/pillows, night light, and window over the port side of the ship. The bathroom has a bathtub and shower. There is also a region specific iPad, mini stereo, capsule coffee maker, fully stocked mini bar, iPod alarm clock with audio line and several arm chairs.

SHACKLETON SUITE ●

Located on decks 4 and 5 these cabins are separated into two spacious rooms, one that is ideal for relaxation with a sofa (convertible to bed), large table, writing desk, chair, ample storage and a large window that can be opened. A separate private bedroom has a double berth with upgraded linen/pillows, night light, private facilities, a region specific iPad, mini stereo, capsule coffee maker, fully stocked mini bar, iPod alarm clock with audio line.

SUPERIOR CABIN ●

These very large cabins are located on deck 6, and feature two lower berths, a loveseat or chairs, writing desk and chair, ample storage and private washroom facilities. All cabins have a window that can be opened. These cabins provide great access to the outer observation decks and ship's bridge.

TWIN PRIVATE CABIN ●

Located on decks 4 and 5 these spacious, well-appointed cabins feature two lower berths, with private washroom facilities (sink, shower, toilet and bathroom cabinet). There are tall wardrobes with internal shelving for storage, a writing desk, chair, bookshelf, and a window that can be opened.

TWIN SEMI PRIVATE ●

Located on deck 4 these cabins have two lower berths, one of which can be converted to a sofa during the day. These cabins have tall wardrobes with internal shelving for storage, a writing desk, chair, bookshelf, and a window that can be opened. Facilities are semi-private – meaning you share the washroom with the adjacent cabin.

MAIN DECK TRIPLE ●

Located on deck 3 these cabins feature two lower berths and one upper berth. One lower berth can be converted to a comfortable sofa during the day. Washroom facilities are shared. There is a washbasin in the cabin, a writing desk and chair and ample storage for all cabin occupants. These cabins are efficient and well-appointed with two portholes with the option to open one.

ONE OCEAN VOYAGER

AKADEMIK SERGEY VAVILOV

CABIN & VOYAGE INCLUSIONS	TRIPLE SHARE	TWIN SEMI-PRIVATE	TWIN PRIVATE	SUPERIOR	SHACKLETON SUITE	ONE OCEAN SUITE
OUTSIDE VIEW WITH OPENING PORTHOLE/WINDOW	●	●	●	●	●	●
COMPLIMENTARY USE OF EXPEDITION GEAR PACKAGE (JACKET, PANTS, BOOTS)	●	●	●	●	●	●
COMPLIMENTARY USE OF BINOCULARS, TRECKING POLE & WATERPROOF BACKPACK	●	●	●	●	●	●
CUSTOM BLEND NATURAL CANADIAN-MADE WASHROOM AMENITIES	●	●	●	●	●	●
CUSTOM CANADIAN-MADE LINEN & 'DREAM-SLEEP' PACKAGE	●	●	●	●	●	●
100% COTTON BATHROBE	●	●	●	●	●	●
HAIR DRYER	●	●	●	●	●	●
DIGITAL CLOCK WITH MEDIA CONNECTOR	●	●	●	●	●	●
IN-ROOM TEA & COFFEE STATION	●	●	●	●	●	●
WELCOME PACKAGE & STAINLESS-STEEL WATER BOTTLE	●	●	●	●	●	●
DESK WITH CHAIR	●	●	●	●	●	●
ONE OCEAN EXPEDITIONS WILDLIFE/FIELD GUIDE			●	●	●	●
IN-ROOM PRIVATE REFERENCE LIBRARY				●	●	●
IN-ROOM IPAD PRELOADED WITH REFERENCE & FICTIONAL CONTENT					●	●
DELUXE WELCOME PACKAGE (WINE, FRUIT BASKET & SNACKS)					●	●
SINGLE BREW COFFEE MACHINE					●	●
MINI STEREO					●	●
PRIVATE IN-ROOM ONE OCEAN ADVENTURE CONCIERGE SERVICE					●	●
IN-ROOM MINI-BAR REPLENISHED DAILY (INCL. SPIRITS)					●	●
COMPLIMENTARY FIELD GUIDE					●	●





DECK 5

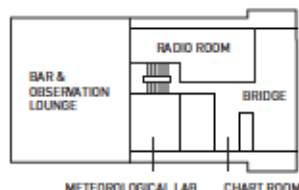

DECK 6

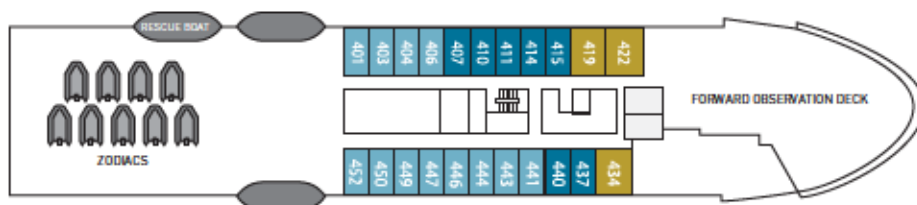

DECK 4

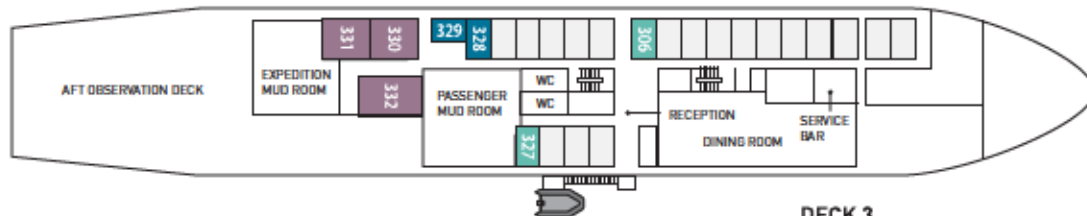

DECK 3

ONE OCEAN VOYAGER

Designed for long range polar research, the One Ocean Voyager (Akademik Sergey Vavilov) is modern, comfortable, safe and ice-strengthened. The vessel features numerous passenger areas ideal for small group briefings or information sessions. An expansive observation lounge and bar offers sweeping 180 degree views, making it an ideal location for catching up over drinks or writing in your journal. The library and reading room are well stocked with polar, fiction and non-fiction and is a wonderful spot to enjoy some reading. The sumptuous meals prepared for you by our culinary team are enjoyed in our dining room, which can host all clients in a single seating and will keep you feeling healthy and strong for the myriad of activities offered throughout your voyage. Other facilities include the theatre-style presentation room, gift-shop, fitness room, massage room, hot water spa, sauna and plunge pool.

ONE OCEAN SUITE ●

Located on deck 5 this cabin is separated into two very spacious rooms. A spacious lounge area is perfect for relaxation and features a sofa (convertible to bed), large table, writing desk, ample storage, plus large picture windows overlooking the bow (forward facing) that can be opened. The separate bedroom features a double bed with upgraded linen/pillows, night light, and window over the port side of the ship. The bathroom has a bathtub and shower. There is also a region specific iPad, mini stereo, capsule coffee maker, fully stocked mini bar, iPod alarm clock with audio line and several arm chairs.

SHACKLETON SUITE ●

Located on decks 4 and 5 these cabins are separated into two spacious rooms, one that is ideal for relaxation with a sofa (convertible to bed), large table, writing desk, chair, ample storage and a large window that can be opened. A separate private bedroom has a double berth with upgraded linen/pillows, night light, private facilities, a region specific iPad, mini stereo, capsule coffee maker, fully stocked mini bar, iPod alarm clock with audio line.

SUPERIOR CABIN ●

There are three superior cabins, all located on Deck 3. These spacious and well-appointed cabins feature two lower berths, a writing desk and chair and plenty of storage space. Washroom facilities are private and all cabins have a porthole, which opens. These cabins provide great access to the outer decks, the dining room and gangway.

TWIN PRIVATE CABIN ●

Located on decks 3, 4 and 5 these spacious, well-appointed cabins feature two lower berths, with private washroom facilities (sink, shower, toilet and bathroom cabinet). There are tall wardrobes with internal shelving for storage, a writing desk, chair, bookshelf, and a window that can be opened. Twin Private cabins on deck 3 feature portholes instead of windows.

TWIN SEMI PRIVATE ●

Located on deck 4 these cabins have two lower berths, one of which can be converted to a sofa during the day. These cabins have tall wardrobes with internal shelving for storage, a writing desk, chair, bookshelf, and a window that can be opened. Facilities are semi-private – meaning you share the washroom with the adjacent cabin.

MAIN DECK TRIPLE ●

Located on deck 3 these cabins feature two lower berths and one upper berth. One lower berth can be converted to a comfortable sofa during the day. Washroom facilities are shared. There is a washbasin in the cabin, a writing desk and chair and ample storage for all cabin occupants. These cabins are efficient and well-appointed with two portholes with the option to open one.

RCGS RESOLUTE

CABIN & VOYAGE INCLUSIONS	MAIN DECK TRIPLE	TWIN PRIVATE	SUPERIOR	SUPERIOR PLUS	SHACKLETON SUITE	ONE OCEAN SUITE
SOMETHING FOR EVERYONE						
OUTSIDE VIEW WITH PANORAMIC WINDOWS (TRIPLE PRIVATE CABINS HAVE PORTHOLE)	●	●	●	●	●	●
COMPLIMENTARY USE OF EXPEDITION GEAR PACKAGE (JACKET, PANTS, BOOTS)	●	●	●	●	●	●
COMPLIMENTARY USE OF BINOCULARS, TRECKING POLE & WATERPROOF BACKPACK	●	●	●	●	●	●
CUSTOM BLEND NATURAL CANADIAN-MADE WASHROOM AMENITIES	●	●	●	●	●	●
CUSTOM CANADIAN-MADE LINEN & 'DREAM-SLEEP' PACKAGE	●	●	●	●	●	●
100% COTTON BATHROBE	●	●	●	●	●	●
HAIR DRYER	●	●	●	●	●	●
DIGITAL CLOCK WITH MEDIA CONNECTOR	●	●	●	●	●	●
IN-ROOM TEA & COFFEE STATION	●	●	●	●	●	●
FLAT-SCREEN ENTERTAINMENT SYSTEM & ONBOARD INTRANET	●	●	●	●	●	●
WELCOME PACKAGE & STAINLESS-STEEL WATER BOTTLE	●	●	●	●	●	●
IN-ROOM SNACK MENU	●	●	●	●	●	●
IN-ROOM MINI-BAR REPLENISHED DAILY (NON-ALCOHOLIC)	●	●	●	●	●	●
ONE OCEAN ADVENTURE CONCIERGE SERVICE	●	●	●	●	●	●
SUPERIOR & ABOVE						
DELUXE CUSTOM BLEND NATURAL CANADIAN-MADE WASHROOM AMENITIES			●	●	●	●
COMPLIMENTARY OOE VOYAGE NOTEBOOK			●	●	●	●
ONE OCEAN EXPEDITIONS WILDLIFE/FIELD GUIDE			●	●	●	●
IN-ROOM MINI BAR REPLENISHED DAILY (INCL. BEER/WINE)			●	●	●	●
IN-ROOM BISTRO MENU			●	●	●	●
DELUXE IN-ROOM ONE OCEAN ADVENTURE CONCIERGE SERVICE			●	●	●	●
SUPERIOR PLUS & ABOVE						
IN-ROOM PRIVATE REFERENCE LIBRARY				●	●	●
IN-ROOM IPAD PRELOADED WITH REFERENCE & FICTIONAL CONTENT				●	●	●
THE SUITES						
EXCLUSIVE CHECK-IN SERVICE ON DAY OF EMBARKATION					●	●
DELUXE WELCOME PACKAGE (AS ABOVE PLUS WINE, FRUIT BASKET & SNACKS)					●	●
SINGLE BREW COFFEE MACHINE					●	●
MINI STEREO					●	●
PRIVATE IN-ROOM ONE OCEAN ADVENTURE CONCIERGE SERVICE					●	●
IN-ROOM DINING MENU					●	●
EARLY MORNING IN-ROOM CAFÉ SERVICE					●	●
EVENING APRÈS DINNER DRINK SERVICE					●	●
PREMIUM IN-ROOM MINI BAR REPLENISHED DAILY (INCL. SPIRITS)					●	●
COMPLIMENTARY 1-HOUR MASSAGE/SPA EXPERIENCE					●	●

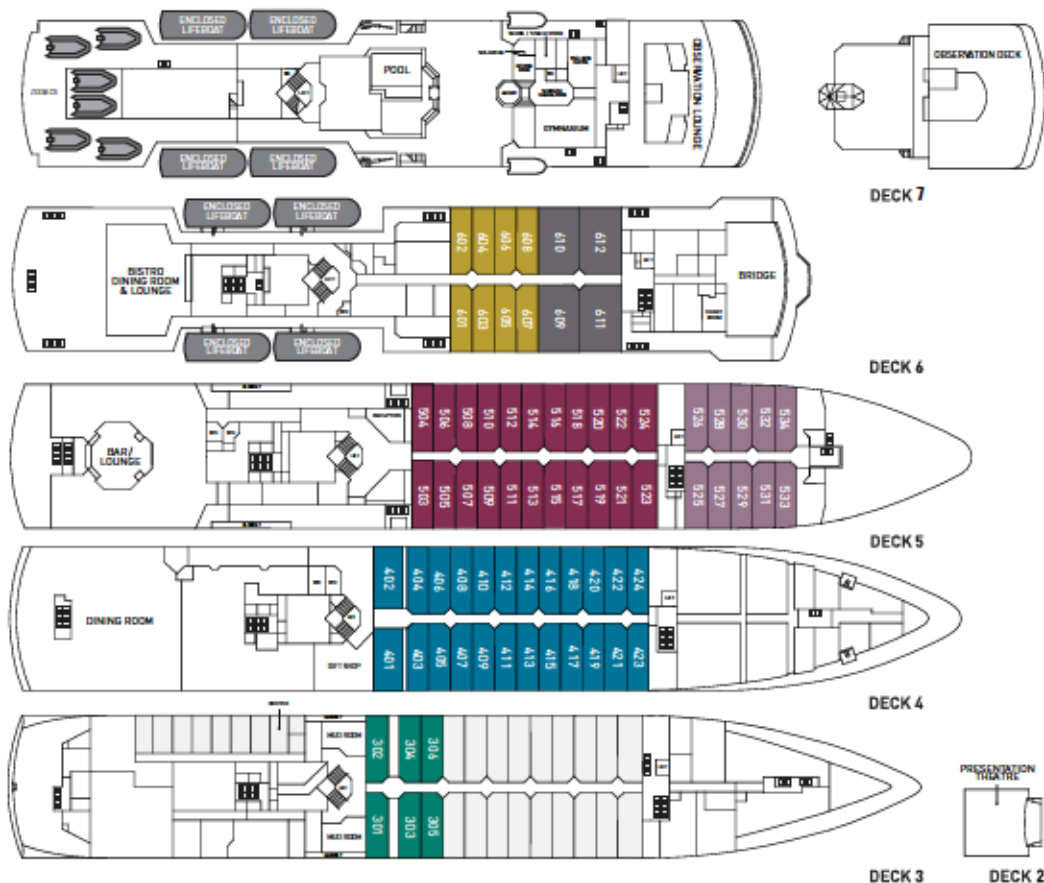

RCGS RESOLUTE

Designed for comfort, the RCGS Resolute is modern, well appointed, safe and ice-strengthened. From small group sessions to briefings for all passengers, we have public spaces onboard the ship ideally suited for each and every need. Two separate bar and lounge areas featuring 180 degree views and a wonderfully stocked library provide ideal places to relax or catch up on some reading. The sumptuous meals prepared for you by our culinary team are enjoyed in either of our two dining rooms, one of which features our popular bistro menu offering quick and easy meals for those prioritizing time out on deck. Both dining rooms have ample and open seating paired with modern furnishings and large picture windows with 180 degree views. Other facilities include our theatre style presentation room, gift-shop, gymnasium, wellness centre, hot water spa, sauna and steam room and salt water pool.

ONE OCEAN SUITE ●

Located on deck 6 these cabins offer ample space (44m²) including the comfort of a sectional lounge with matching club chairs, a large desk, expansive soft close cabinetry, washroom facilities including both a shower & bathtub. Sleeping quarters feature the option for either a double or two single configured beds with upgraded linens/pillows. Included are a night light, region specific iPad, mini stereo, coffee maker, fully stocked mini bar, iPod alarm clock with audio line, private flora and fauna library all to enjoy amidst the large picture windows overlooking either the port or starboard side of the vessel.

SHACKLETON SUITE ●

Located on deck 6 these cabins offer ample space (22m²) including the comfort of a sectional lounge, a large desk, expansive soft close cabinetry, washroom facilities including both a shower & bathtub. Sleeping quarters feature the option for either a double or two single configured beds with upgraded linens/pillows. Included are a night light, region specific iPad, mini stereo, coffee maker, fully stocked mini bar, iPod alarm clock with audio line, private flora and fauna library all to enjoy amidst the large picture windows overlooking either the port or starboard side of the vessel.

SUPERIOR PLUS CABIN ●

Located forward on deck 5 these cabins feature the option for either a double or two single configured beds. A sectional lounge is placed by the large picture windows, writing desk/chair, ample storage and private washroom facilities. These cabins are spacious and well appointed.

SUPERIOR CABIN ●

Located forward on deck 5 these cabins feature the option for either a double or two single configured beds. A sectional lounge is placed by the large picture windows, writing desk/chair, ample storage and private washroom facilities. These cabins are spacious and well appointed.

TWIN PRIVATE CABIN ●

Located on deck 4 these cabins feature the option for either a double or two single configured beds. A sectional lounge is placed by the large picture windows, writing desk/chair, ample storage and private washroom facilities. These cabins are spacious and well appointed.

MAIN DECK TRIPLE ●

Located on deck 3 these cabins feature the option for a double or two single configured beds and a convertible sofa lounge to a lower berth. A sectional lounge is placed by the portholes, writing desk/chair, ample storage and private washroom facilities. These cabins are spacious and well appointed.





ONE CLUB EXPEDITION ALUMNI

Come as a passenger, leave as a friend. Once you have experienced one voyage with us, it's likely you will want to experience another. Your commitment to travel with us is rewarded with our commitment to you, our valued guest. As members of the One Club Expedition Alumni, your loyalty is rewarded with a range of great travel benefits when you return for your next voyage — no matter the destination.



THERE IS ONLY
ONE OCEAN

